

# Absolute Encoder

## 绝对式编码器

### Operation Manual

#### 使用说明书

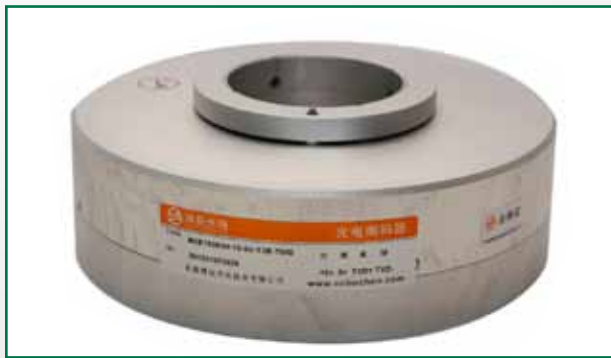

RDE165T60 • Series

# Contents

## Product Description

1.1	Appearance and Features .....	1
1.2	Part Number Defined(1) .....	1
	Part Number Defined(2) .....	1
1.3	Notes .....	1

## Product Specifications

2.1	Basic Specifications .....	1
2.2	Environment Specifications .....	1
2.3	Mechanical Specifications .....	2
2.4	Electrical Specifications (1) .....	2
	Electrical Specifications (2) .....	2
2.5	Installation Instruction .....	2

## Product Communication

### Asynchronous serial

#### 3.1 RS485

3.1.1	Timing Transmission .....	3
3.1.2	Timing Transmission+Zero Clearing .....	4
3.1.3	Handshake .....	5
3.1.4	Handshake+Zero Clearing .....	6
3.1.5	Bus Command .....	7
3.1.6	Bus+Zero Clearing .....	7
3.1.7	MODBUS .....	8

#### 3.2 RS232

3.2.1	Timing Transmission .....	9
3.2.2	Timing Transmission+Zero Clearing .....	10
3.2.3	Handshake .....	11
3.2.4	Handshake+Zero Clearing .....	12
3.2.5	Bus Command .....	13
3.2.6	Bus+Zero Clearing .....	13

#### 3.3 RS422

3.3.1	Timing Transmission .....	14
3.3.2	Timing Transmission+Zero Clearing .....	15
3.3.3	Bus Command .....	16
3.3.4	Bus+Zero Clearing .....	17

#### 3.4 CAN

3.4.1	CANopen .....	18
-------	---------------	----

### Synchronous Serial

3.4	SSI .....	20
-----	-----------	----

## 1.1 Appearance and Features

### Appearance:

- 1.Shell Color: Black、Silver (Optional) .
- 2.Surface Treatment: Sandblast Oxidation.
- 3.Termination: Radial Output.
- 4.Cable Length: 1m (Can be customized) .
- 5.Color of Cable: Black、Gray (Optional) .

### Features:

- 1.Large hollow shaft diameter products, military standards.
- 2.Durable, long life, high precision, anti-interference.
- 3.Wide temperature range, suitable for all kinds of environments.

RDE165T60

## 1.2 Part Number Defined

### (1) Asynchronous Serial Communication

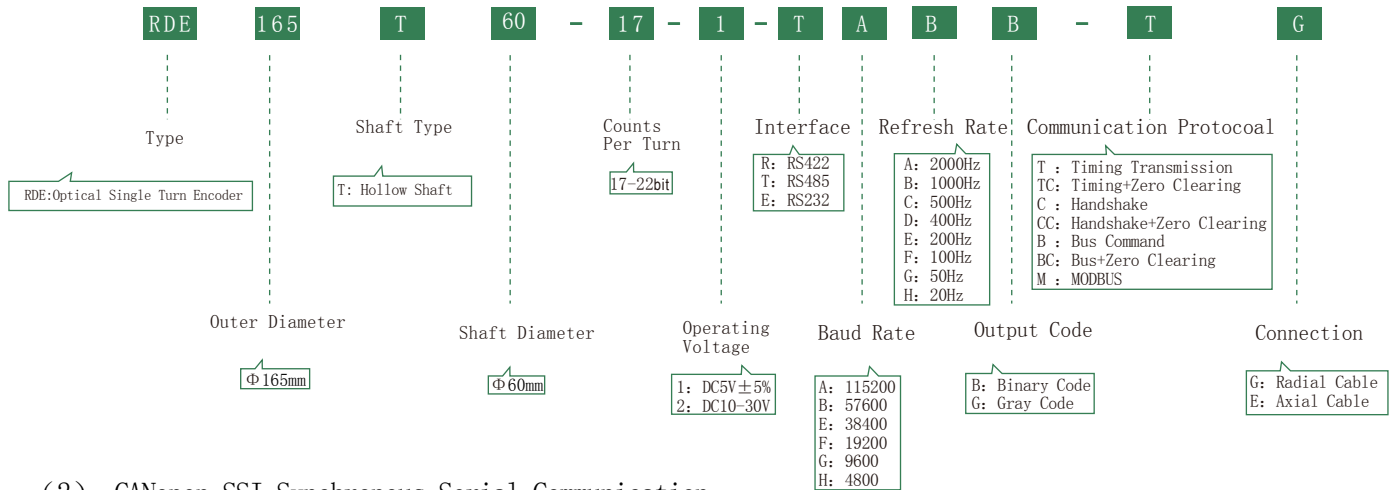

### (2) CANopen. SSI. Synchronous Serial Communication

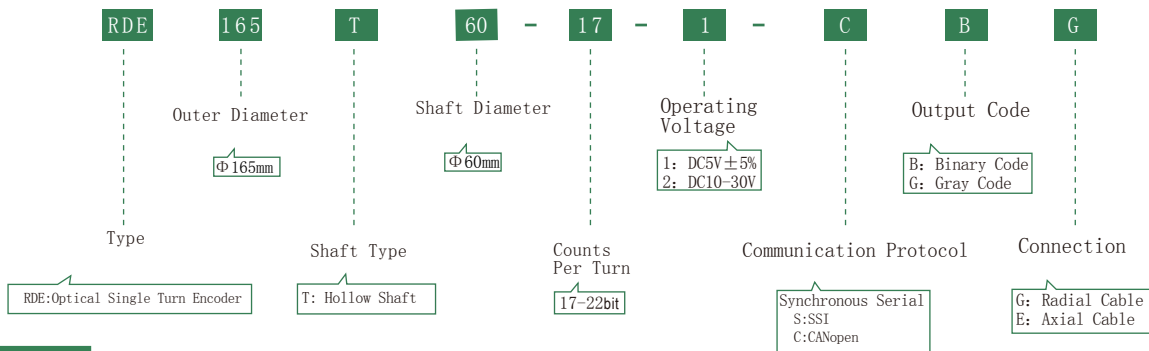

## 1.3 Notes

1. Please follow the instructions to use flexible connections for mounting to ensure the accuracy and service life of products.
2. Encoders are precise instruments adjusted strictly before leaving factory. Strong impact, dismantlement and changes on encoders are not allowed.
3. To guarantee the accuracy and work of encoder, when the operating voltage is DC5V ± 5%:
  - (1) Cable length should not exceed 2 meters.
  - (2) The current of the power supply should not be less than 0.5A.
  - (3) The interference signal of the power supply should be within ± 50mV.
- When operating voltage is 10-30V:
  - (1) The current of the power supply should not be less than 0.3A.
  - (2) The interference signal of the power supply should be within ± 50mV.
4. The corresponding supply voltage and connections to the equipment should be paid attention by the professional installation people.
5. Please read the instructions carefully before using the product.

## 2.1 Basic Specifications

Resolution in Bit	17~22bit	Measuring Range	0 ~ 360° (Single-turn)			
Resolution in Bit	17 bit	18 bit	19 bit	20 bit	21 bit	22 bit
Angular Resolution	10"	5"	2.5"	1.2"	0.6"	0.3"
Accuracy≤	±20"	±15"	±10"	±7.5"	±6"	±4"

## 2.2 Environment Specifications

Working Temperature	-40℃~+65℃	Protection Class	IP54
Storage Temperature	-50℃~+70℃		

## 2.3 Mechanical Specifications

Outer Diameter	165 mm	Shaft Diameter	60 mm
Height	48 mm	Max Speed	300 r/min
Weight	2350 g	Radial Shaft Load	≤40N
Vibration	2.5 g	Axial Shaft Load	≤20N
Shock	20 g		

## 2.4 Electrical Specifications

### (1) Asynchronous Serial Communication

Supply Voltage	DC5V, 10~30V
Interface	RS485, RS422, RS232, CAN
Communication Protocol	MODBUS, CANopen, Timing Transmission, Timing Transmission+Zero Clearing, Handshake, Handshake+Zero Clearing, Bus Command, Bus+Zero Clearing
Baud Rate(b/s)	115200, 57600, 38400, 19200, 9600, 4800, 2400
Refresh Rate	2000Hz, 1000Hz, 500 Hz, 400 Hz, 200 Hz, 100 Hz, 50 Hz, 20 Hz
Output Code	Binary Code, Gray Code

### (2) Synchronous Serial Communication

Supply Voltage	DC5V, 10~30V
Communication Protocol	SSI
Output Code	Binary Code, Gray Code

## 2.5 Installation Instruction

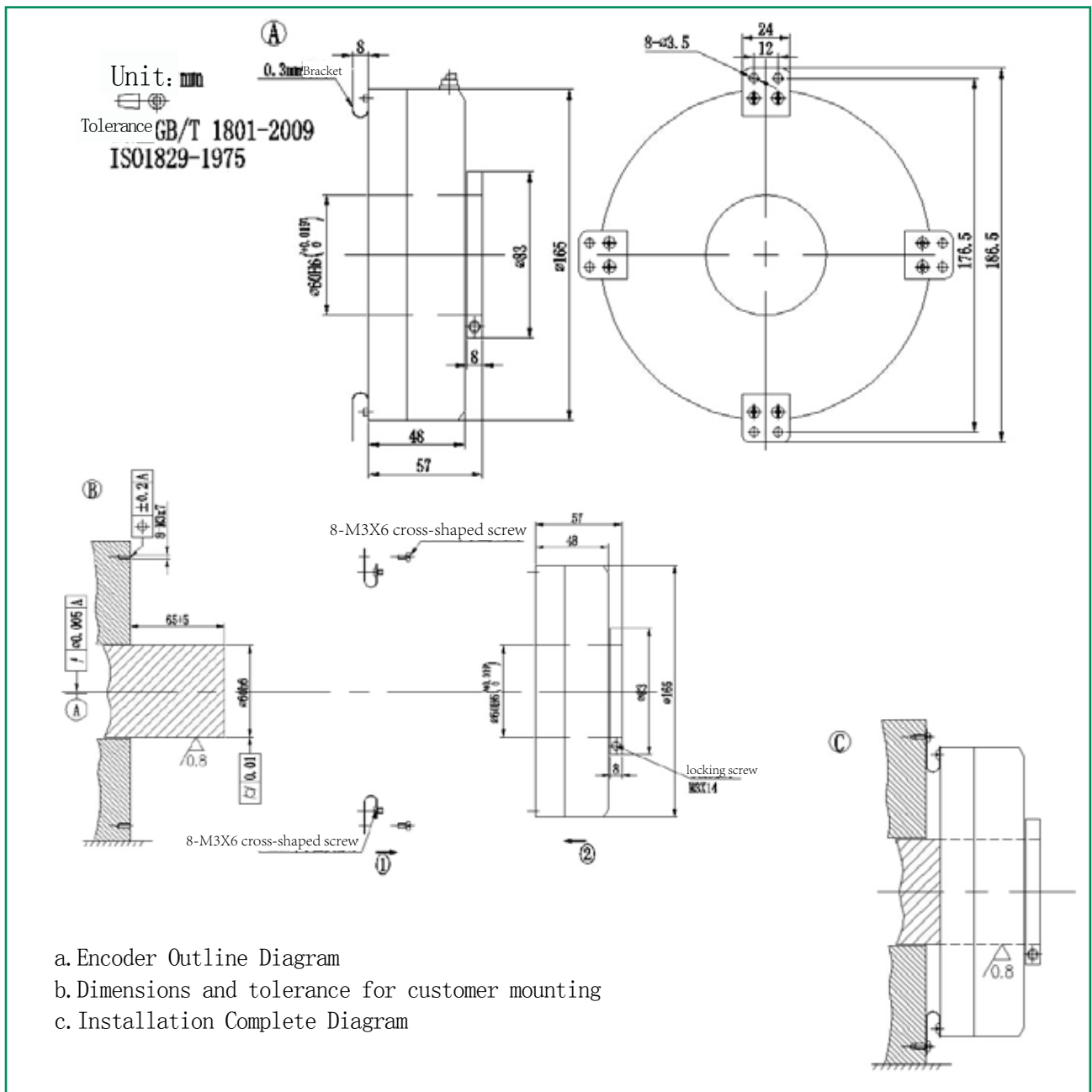

**Asynchronous serial:** Number of data bits per character :10 Bits start bits - 1 data bits - 8 parity bits - 0 stop bits - 1 Bit transfer order:LSB first (Odd Parity Check and even parity check are optional for customer requirements)

3.1 RS485

RS485 interface chip---MAX485 ESA (250kbps) or MAX13443EASA (10Mbps)

3.1.1 Timing Transmission

(1) Output data waveform

For Example, 0xff 0x81 0xd0 ...

- TXD+ Bit Transmission: 0 1111 1111 1 0 1000 0001 1 0 0000 1011 1 ...  
3.3V ≤ L ≤ 5V

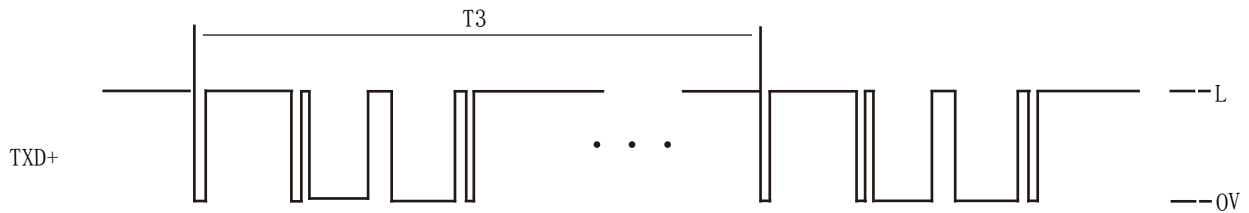

- TXD- Bit Transmission: 1 0000 0000 0 1 0111 1110 0 1 1111 0100 0 ...  
3.3V ≤ L ≤ 5V

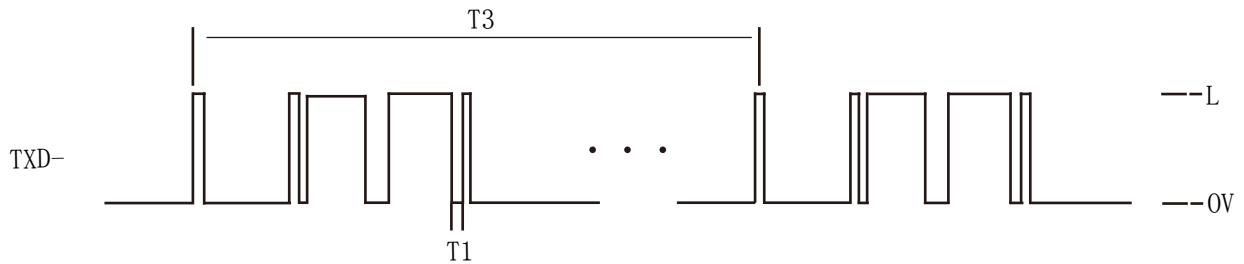

T1: Baud Rate T3: Refresh Rate

(2) Data Frame Format

	1 <sup>st</sup> Byte	2 <sup>nd</sup> Byte	3 <sup>rd</sup> Byte	4 <sup>th</sup> Byte	5 <sup>th</sup> Byte	6 <sup>th</sup> Byte	7 <sup>th</sup> Byte
≤16bit	FFH	81H	The Top Eight Bits	The Bottom Eight Bits	Checksum		
17~24bit	FFH	81H	The Top Eight Bits	The Middle Eight Bits	The Bottom Eight Bits	Checksum	
>24bit	FFH	81H	The Top Eight Bits	The Sub-top Bits	The Middle Eight Bits	The Bottom Eight Bits	Checksum

(Checksum is the sum of first n bytes data and rounded up to the bottom eight bits. n=4(≤16bit); n=5(17~24bit);n=6(>24bit))

(3) Connection

Color	RED	BLACK	YELLOW	GREEN	WHITE	SHIELD
Signal	VCC	0V	TXD+	TXD-	NC	G

(4) Angle Conversion Formula

$$\theta = (360^\circ \times a) / 2^n \quad [a: \text{data (decimal)}, n: \text{encoder bits}]$$

Take an example of 14 bit absolute encoder, returned data FFH 81H 01H 7FH 00H, data bit 01H 7FH (decimal) 383, Checksum 00H.

$$a=383, n=14, \theta = (360^\circ \times 383) / 2^{14}, \theta = (360^\circ \times 383) / 16384, \theta = 8.4155^\circ$$

### 3.1.2 Timing Transmission + Zero Clearing

#### (1) Output data waveform

For Example 0xff 0x81 0xd0 ...

■ TXD+ Bit Transmission: 0 1111 1111 1 0 1000 0001 1 0 0000 1011 1 ...

3.3V ≤ L ≤ 5V

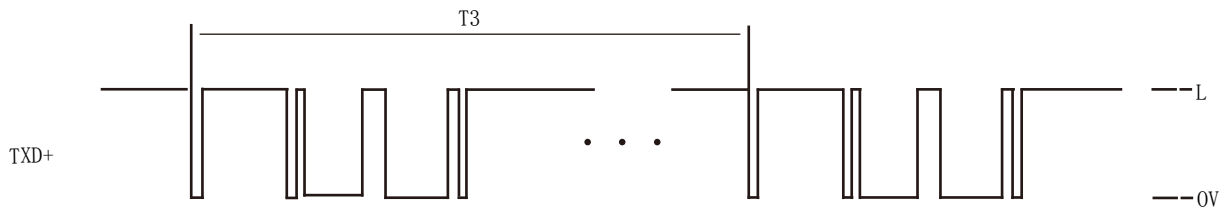

■ TXD- Bit Transmission: 1 0000 0000 0 1 0111 1110 0 1 1111 0100 0 ...

3.3V ≤ L ≤ 5V

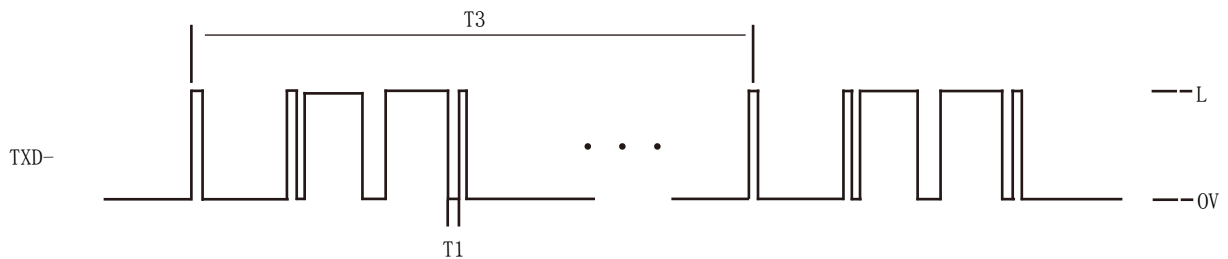

T1: Baud Rate    T3: Refresh Rate

#### (2) Data Frame Format

	1 <sup>st</sup> Byte	2 <sup>nd</sup> Byte	3 <sup>rd</sup> Byte	4 <sup>th</sup> Byte	5 <sup>th</sup> Byte	6 <sup>th</sup> Byte	7 <sup>th</sup> Byte
≤16bit	FFH	81H	The Top Eight Bits	The Bottom Eight Bits	Checksum		
17~24bit	FFH	81H	The Top Eight Bits	The Middle Eight Bits	The Bottom Eight Bits	Checksum	
>24bit	FFH	81H	The Top Eight Bits	The Sub-top Bits	The Middle Eight Bits	The Bottom Eight Bits	Checksum

(Checksum is the sum of first n bytes data and rounded up to the bottom eight bits. n=4(≤16bit); n=5(17~24bit); n=6(>24bit))

#### (3) Connection

Color	Red	Black	Yellow	Green	White	Shield
Signal	VCC	0V	TXD+	TXD-	CLR	G

#### (4) Angle Conversion Formula

$$\theta = (360^\circ \times a) / 2^n \quad [a: \text{data (decimal)}, n: \text{encoder bits}]$$

Take an example of 14 bit absolute encoder, returned data FFH 81H 01H 7FH 00H, data bit 01H 7FH (decimal) 383, Checksum 00H.

$$a=383, n=14, \theta = (360^\circ \times 383) / 2^{14}, \theta = (360^\circ \times 383) / 16384, \theta = 8.4155^\circ$$

#### (5) Zero Clearing Signal:

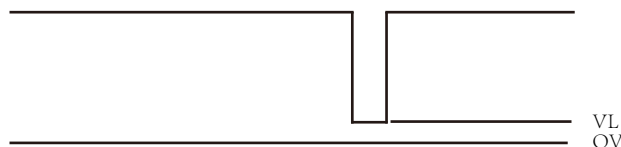

Normally the voltage of CLR pin is 3.3V; When customer input a falling edge pulse and VL < 0.5V, zero cleared.

### 3.1.3 Handshake

#### (1) Output Data Wave Form

For example 0xff 0x81 0xd0 ...

TXD+ Bit Transmission: 0 1111 1111 1 0 1000 0001 1 0 0000 1011 1 ...

$3.3V \leq L \leq 5V$

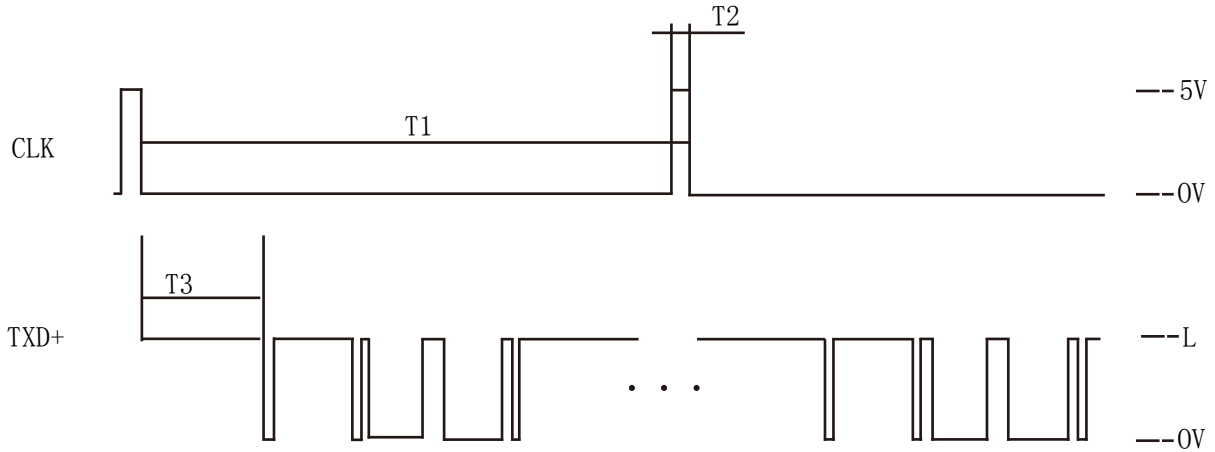

The falling edge of outer pulses signal triggers encoder working

$T2 \geq 10\mu s$

T3: Signal acquisition and processing time after receiving the falling edge outer pulse.

T1-T3: Data transmission time

T1, T3 will be different according to customer's requirements.

#### (2) Data Frame Format

	1 <sup>st</sup> Byte	2 <sup>nd</sup> Byte	3 <sup>rd</sup> Byte	4 <sup>th</sup> Byte	5 <sup>th</sup> Byte	6 <sup>th</sup> Byte	7 <sup>th</sup> Byte
$\leq 16\text{bit}$	FFH	81H	The Top Eight Bits	The Bottom Eight Bits	Checksum		
17~24bit	FFH	81H	The Top Eight Bits	The Middle Eight Bits	The Bottom Eight Bits	Checksum	
>24bit	FFH	81H	The Top Eight Bits	The Sub-top Bits	The Middle Eight Bits	The Bottom Eight Bits	Checksum

(Checksum is the sum of first n bytes data and rounded up to the bottom eight bits.  $n=4(\leq 16\text{bit})$ ;  $n=5(17\sim 24\text{bit})$ ;  $n=6(>24\text{bit})$ )

#### (3) Connections

Color	Red	Black	Yellow	Green	White	Shield
Signal	VCC	0V	TXD+	TXD-	CLK	G

#### (4) Angle Conversion Formula

$\theta = (360^\circ \times a) / 2^n$  [a: data (decimal), n: encoder bits]

Take an example of 14 bit absolute encoder, returned data FFH 81H 01H 7FH 00H, data bit 01H 7FH (decimal) 383, Checksum 00H.

$a=383, n=14, \theta = (360^\circ \times 383) / 2^{14}, \theta = (360^\circ \times 383) / 16384, \theta = 8.4155^\circ$ .

### 3.1.4 Handshake+Zero Clearing

#### (1) Output Data Wave Form

For example 0xff 0x81 0xd0 ...

TXD+ Bit Transmission: 0 1111 1111 1 0 1000 0001 1 0 0000 1011 1 ...

$3.3V \leq L \leq 5V$

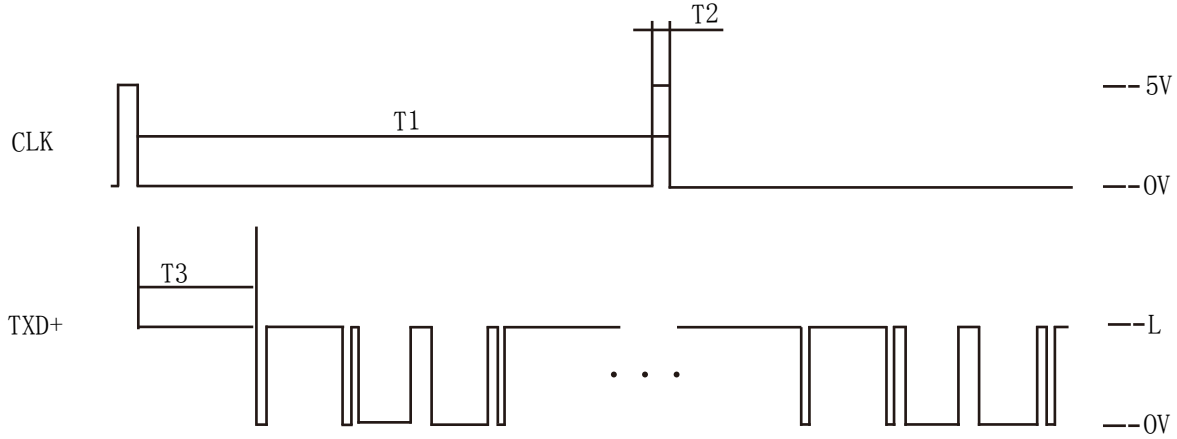

The falling edge of outer pules signal triggers encoder working

$T2 \geq 10\mu s$

T3: Signal acquisition and processing time after receiving the falling edge outer pulse.

T1-T3: Data transmission time

T1、T3 will be different according to customer' s requirements.

#### (2) Data Frame Format

	1 <sup>st</sup> Byte	2 <sup>nd</sup> Byte	3 <sup>rd</sup> Byte	4 <sup>th</sup> Byte	5 <sup>th</sup> Byte	6 <sup>th</sup> Byte	7 <sup>th</sup> Byte
$\leq 16\text{bit}$	FFH	81H	The Top Eight Bits	The Bottom Eight Bits	Checksum		
17~24bit	FFH	81H	The Top Eight Bits	The Middle Eight Bits	The Bottom Eight Bits	Checksum	
$> 24\text{bit}$	FFH	81H	The Top Eight Bits	The Sub-top Bits	The Middle Eight Bits	The Bottom Eight Bits	Checksum

(Checksum is the sum of first n bytes data and rounded up to the bottom eight bits.  $n=4(\leq 16\text{bit})$ ;  $n=5(17\sim 24\text{bit})$ ;  $n=6(> 24\text{bit})$ )

#### (3) Connections (8 core cable)

Color	Red	Black	Yellow	Green	Gray	White	Orange	Brown	Shield
Signal	VCC	0V	TXD+	TXD-	CLK	CLR	NC	NC	G

#### (4) Angle Conversion Formula

$\theta = (360^\circ \times a) / 2^n$  [a: data (decimal) , n: encoder bits]

Take an example of 14 bit absolute encoder, returned data FFH 81H 01H 7FH 00H, data bit 01H 7FH (decimal) 383, Checksum 00H.

$a=383, n=14, \theta = (360^\circ \times 383) / 2^{14}, \theta = (360^\circ \times 383) / 16384, \theta = 8.4155^\circ$  .

#### (5) Zero Clearing Signal:

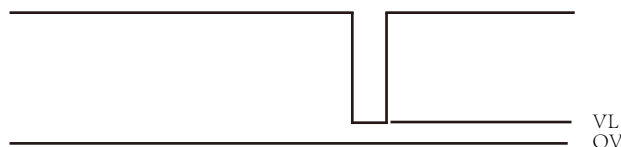

Normally the voltage of CLR pin is 3.3V; When customer input a falling edge pulse and  $VL < 0.5V$ , zero cleared.



### 3.1.5 Bus Command

(1) Control command:

BC AA BX (BX: Command Number. If customers don't have special requirements, each encoder within same batch has sole command number. This number will be also used as encoder address number.)

For example, 3 encoders in same batch. control command: BC AA B1、BC AA B2、BC AA B3; Corresponding returned data: FF B1……, FF B2 ……., FF B3 …….; The second byte of returned data is product address number.

(2) Data Frame Format

	1 <sup>st</sup> Byte	2 <sup>nd</sup> Byte	3 <sup>rd</sup> Byte	4 <sup>th</sup> Byte	5 <sup>th</sup> Byte	6 <sup>th</sup> Byte	7 <sup>th</sup> Byte
Control command	BCH	AAH	BXH				
≤16bit	FFH	81H	The Top Eight Bits	The Bottom Eight Bits	Checksum		
17~24bit	FFH	81H	The Top Eight Bits	The Middle Eight Bits	The Bottom Eight Bits	Checksum	
>24bit	FFH	81H	The Top Eight Bits	The Sub-top Bits	The Middle Eight Bits	The Bottom Eight Bits	Checksum

(Checksum is the sum of first n bytes data and rounded up to the bottom eight bits. n=4(≤16bit); n=5(17~24bit); n=6(>24bit))

(3) Connection

Color	RED	BLACK	YELLOW	GREEN	WHITE	SHIELD
Signal	VCC	0V	TXD+	TXD-	NC	G

(4) Angle Conversion Formula

$$\theta = (360^\circ \times a) / 2^n \quad [a: \text{data (decimal)}, n: \text{encoder bits}]$$

Take an example of 14 bit absolute encoder, returned data FFH 81H 01H 7FH 00H, data bit 01H 7FH (decimal) 383, Checksum 00H.

$$a=383, n=14, \theta = (360^\circ \times 383) / 2^{14}, \theta = (360^\circ \times 383) / 16384, \theta = 8.4155^\circ .$$

### 3.1.6 Bus + Zero Clearing

(1) Control command:

BC AA BX (BX: Command Number. If customers don't have special requirements, each encoder within same batch has sole command number. This number will be also used as encoder address number.)

For example, 3 encoders in same batch. control command: BC AA B1、BC AA B2、BC AA B3; Corresponding returned data: FF B1……, FF B2 ……., FF B3 …….; The second byte of returned data is product address number.

Zero clearing command:

BC AA CX . (CX: zero clearing command. If customers don't have special requirements, each product in same batch has sole zero clearing command. Generally, the X in zero clearing command is corresponding with the X in control command.)

For example, when control command is BC AA B1, its zero clearing command is BC AA C1.

(2) Data Frame Format

	1 <sup>st</sup> Byte	2 <sup>nd</sup> Byte	3 <sup>rd</sup> Byte	4 <sup>th</sup> Byte	5 <sup>th</sup> Byte	6 <sup>th</sup> Byte	7 <sup>th</sup> Byte
Control Command	BCH	AAH	BXH				
Zero Clearing Command	BCH	AAH	CXH				
≤16bit	FFH	81H	The Top Eight Bits	The Bottom Eight Bits	Checksum		
17~24bit	FFH	81H	The Top Eight Bits	The Middle Eight Bits	The Bottom Eight Bits	Checksum	
>24bit	FFH	81H	The Top Eight Bits	The Sub-top Bits	The Middle Eight Bits	The Bottom Eight Bits	Checksum

(Checksum is the sum of first n bytes data and rounded up to the bottom eight bits. n=4(≤16bit); n=5(17~24bit); n=6(>24bit))

(3) Connection

Color	RED	BLACK	YELLOW	GREEN	WHITE	SHIELD
Signal	VCC	0V	TXD+	TXD-	NC	G

(4) Angle Conversion Formula

$$\theta = (360^\circ \times a) / 2^n \quad [a: \text{data (decimal)}, n: \text{encoder bits}]$$

Take an example of 14 bit absolute encoder, returned data FFH 81H 01H 7FH 00H, data bit 01H 7FH (decimal) 383, Checksum 00H.

$$a=383, n=14, \theta = (360^\circ \times 383) / 2^{14}, \theta = (360^\circ \times 383) / 16384, \theta = 8.4155^\circ .$$

### 3.1.7 MODBUS Protocol

- (1) Modbus Communication Protocol (RTU mode)。
- (2) Baud Rate: 2400bps 4800bps 9600bps 19200bps 57600bps
- (3) Factory Default Settings:①no odd-even parity ②Baud rate 19200bps③ address 0x01④ starting address 0x00 0x00  
Note: When changing parameters, do not regularly send in case the internal structure of the device would be damaged.

Sending a return match on behalf of the data was set successfully.

(4) Function Code 03:

The 03 code function of Modbus communication protocol could help reading the encoder values.

The slave address, function code, starting address, number of bytes and CRC code are all included in command format of the master.

The format of slave response data is made up with the slave address, function code, data areas and CRC code. The data area is a binary code, two bytes (or three bytes), MSB first. CRC code is two bytes, LSB first.

(5) Data Frame Format:

- ① The reading real-time data of encoder is below - 16bit when the master is calling, the slave address is 01

01	03	00	00	00	01	84	0A
Slave address	Function code	Starting address	Reading points		CRC checksum(LSB first)		

Encoder Answering:

01	03	02	XX	XX	XX	XX
Slave address	Function code	Starting address	data (MSB first)		CRC checksum(LSB first)	

- ② The reading real-time data of encoder is between - 16bit and - 32bit when the master is calling, the slave address is 01

01	03	00	00	00	02	C4	0B
Slave address	Function code	Starting address	Reading points		CRC checksum(LSB first)		

Encoder Answering:

01	03	04	XX	XX	XX	XX	XX
Slave address	Function code	Single unit byte	data (MSB first)		CRC checksum(LSB first)		

01, 03, 02, XX, etc. above are all a byte. The data is two bytes, the higher byte ahead.

The interval time between the beginning and the end of each frame is at least 3.5 bytes.

When users programming for the master, in addition to the station number (address) and the CRC checksum code, all other byte characters used in the above remains unchanged. The reading points in the master format could be 01 or 02 (02 is for compatible with certain protocols). The function code 03 in the slave remains unchanged.

③ Check Device Address

Master calling	FF	A0	40	38
Encoder answering	FF	A0	01 (Slave address)	XX XX (CRC checksum code, MSB first)

④ Check Device Address

Mastering calling	01	A1	02 (new address)	XX XX (CRC checksum code, LSB first)
Encoder answering	02 (new address)	A1	XX:XX (CRC checksum code, LSB first)	

⑤ Change the baud , zero position and direction of device

Master calling	01	CC	02 (parameter)	XX XX (CRC checksum code, LSB first)
Encoder answering	01 (address)	CC	02 (parameter)	XX XX (CRC checksum code, LSB first)

Definition of Setting:

I、0x00 Set the current position to zero; II、0x01 positive bit; III、0x02 negative bit;

IV、0x24 Baud Rate 2400bps; V、0x48 Baud Rate 4800bps;VI、0x96 Baud Rate 9600bps;

VII、0x19 Baud Rate 19200bps; VIII、0x57 Baud Rate 57600bps;

The steps of calculating the CRC code is:

- ① Preset 16 bits slave is hexadecimal coding FFFF (that is 1 for all) .We call this kind of slave as CRC slave;
- ② Exclusive OR the first 8-bit data with 16-bit CRC slave low-XOR, put the result into CRC slave;
- ③ Move one bit of the slave into right direction(towards low), filling the highest position with 0, checking the lowest position;
- ④ If the lowest bit (the moved out one) is 0: then repeat Step 3 (shifted again)  
If the lowest bit (the moved out one) is 1: Exclusive OR CRC slave with polynomial A001 (1010 0000 0000 0001) ;
- ⑤ Repeat step 3 for and 4 until the right eight times, so that the whole 8-bit data are fully processed;
- ⑥ Repeat from the steps 2 to step 5, and carrying next 8-bit data processing;
- ⑦ The resulting of CRC slave is the CRC code.
- ⑧ Put CRC results into information frames, exchange the low bit with high bit, LSB first.

(6) Connection

Color	RED	BLACK	YELLOW	GREEN	WHITE	SHIELD
Signal	VCC	0V	TXD+	TXD-	NC	G

(7) Angle Conversion Formula

$$\theta = (360^\circ \times a) / 2^n \quad [a: \text{data (decimal)}, n: \text{encoder bits}]$$

Take an example of 14 bit absolute encoder, returned data FFH 81H 01H 7FH 00H, data bit 01H 7FH (decimal) 383, Checksum 00H.

$$a=383, n=14, \theta = (360^\circ \times 383) / 2^{14}, \theta = (360^\circ \times 383) / 16384, \theta = 8.4155^\circ$$

### 3.2.1 Timing Transmission

#### (1) Output Data Waveform

For instance: 0xff 0x81 0xd0 ...

TXD + Bit transfer: 0 1111 1111 1 0 1000 0001 1 0 0000 1011 1 ...

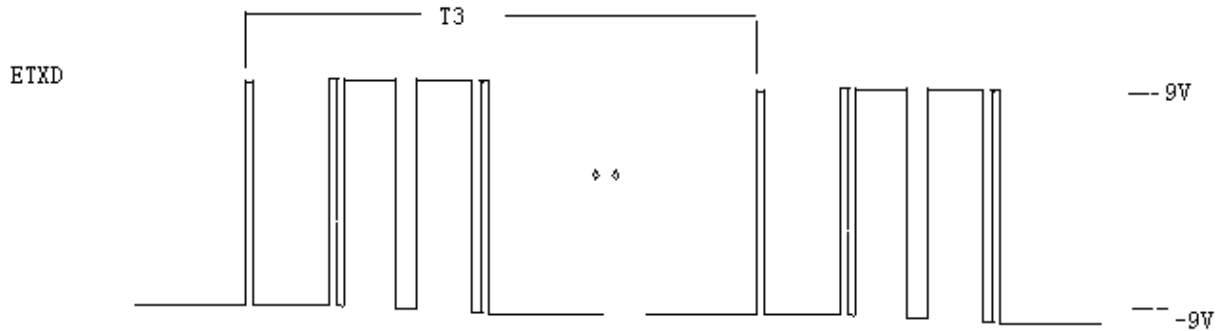

T3: Refresh Rate

#### (2) Data Frame Format

	1 <sup>st</sup> Byte	2 <sup>nd</sup> Byte	3 <sup>rd</sup> Byte	4 <sup>th</sup> Byte	5 <sup>th</sup> Byte	6 <sup>th</sup> Byte	7 <sup>th</sup> Byte
≤16bit	FFH	81H	The Top Eight Bits	The Bottom Eight Bits	Checksum		
17~24bit	FFH	81H	The Top Eight Bits	The Middle Eight Bits	The Bottom Eight Bits	Checksum	
>24bit	FFH	81H	The Top Eight Bits	The Sub-top Bits	The Middle Eight Bits	The Bottom Eight Bits	Checksum

(Checksum is the sum of first n bytes data and rounded up to the bottom eight bits. n=4(≤16bit); n=5(17~24bit); n=6(>24bit))

#### (3) Connections

Color	Red	Black	Yellow	Green	White	Shield
Signal	VCC	0V	ETXD	NC	CLR	G

#### (4) Angle Conversion Formula

$$\theta = (360^\circ \times a) / 2^n \quad [a: \text{data (decimal)}, n: \text{encoder bits}]$$

Take an example of 14 bit absolute encoder, returned data FFH 81H 01H 7FH 00H, data bit 01H 7FH (decimal) 383, Checksum 00H.

$$a=383, n=14, \theta = (360^\circ \times 383) / 2^{14}, \theta = (360^\circ \times 383) / 16384, \theta = 8.4155^\circ.$$

#### (5) Zero Clearing Signal:

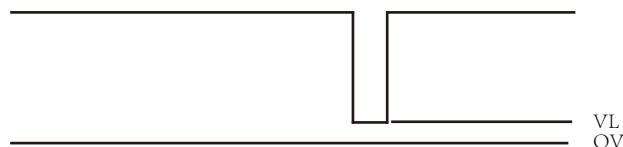

Normally the voltage of CLR pin is 3.3V; When customer input a falling edge pulse and VL<0.5V, zero cleared.

### 3.2.2 Timing Transmission + Zero Clearing

#### (1) Output Data Waveform

For Example 0xff 0x81 0xd0 ...

■ TXD+ Bit Transmission: 0 1111 1111 1 0 1000 0001 1 0 0000 1011 1 ...

$3.3V \leq L \leq 5V$

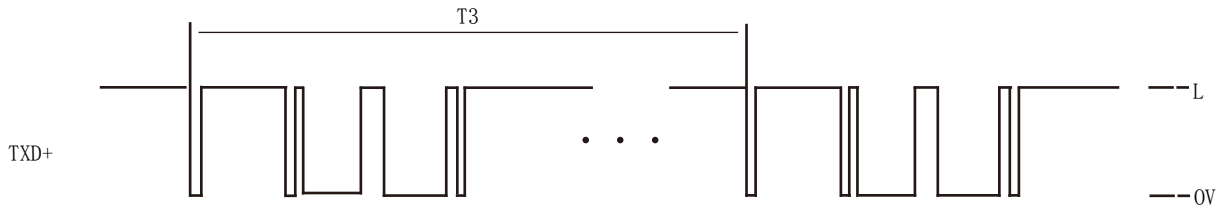

■ TXD- Bit Transmission: 1 0000 0000 0 1 0111 1110 0 1 1111 0100 0 ...

$3.3V \leq L \leq 5V$

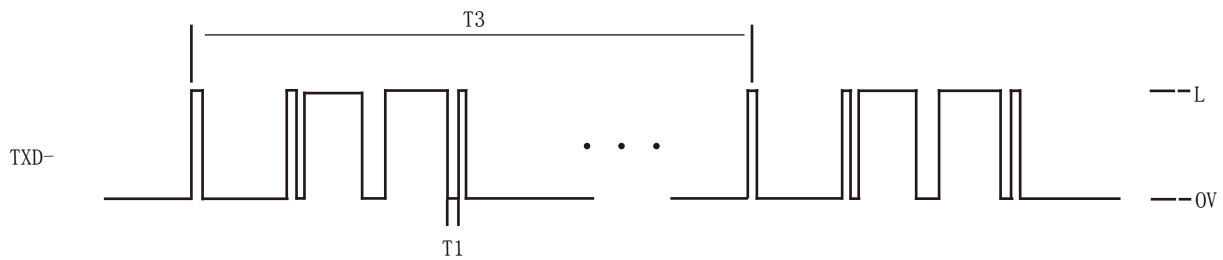

T1: Baud Rate    T3: Refresh Rate

#### (2) Data Frame Format

	1 <sup>st</sup> Byte	2 <sup>nd</sup> Byte	3 <sup>rd</sup> Byte	4 <sup>th</sup> Byte	5 <sup>th</sup> Byte	6 <sup>th</sup> Byte	7 <sup>th</sup> Byte
≤16bit	FFH	81H	The Top Eight Bits	The Bottom Eight Bits	Checksum		
17~24bit	FFH	81H	The Top Eight Bits	The Middle Eight Bits	The Bottom Eight Bits	Checksum	
>24bit	FFH	81H	The Top Eight Bits	The Sub-top Bits	The Middle Eight Bits	The Bottom Eight Bits	Checksum

(Checksum is the sum of first n bytes data and rounded up to the bottom eight bits. n=4(≤16bit); n=5(17~24bit); n=6(>24bit))

#### (3) Connections

Color	Red	Black	Yellow	Green	White	Shield
Signal	VCC	0V	ETXD	NC	CLR	G

#### (4) Angle Conversion Formula

$$\theta = (360^\circ \times a) / 2^n \quad [a: \text{data (decimal)}, \quad n: \text{encoder bits}]$$

Take an example of 14 bit absolute encoder, returned data FFH 81H 01H 7FH 00H, data bit 01H 7FH (decimal) 383, Checksum 00H.

$$a=383, n=14, \theta = (360^\circ \times 383) / 2^{14}, \theta = (360^\circ \times 383) / 16384, \theta = 8.4155^\circ$$

#### (5) Zero Clearing Signal:

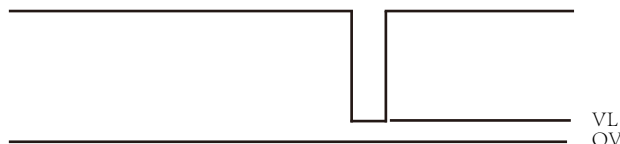

Normally the voltage of CLR pin is 3.3V; When customer input a falling edge pulse and  $V_L < 0.5V$ , zero cleared.

### 3.2.3 Pulse Handshake

#### (1) Output Data Waveform

For instance: 0xff 0x81 0xd0 ...

TXD + Bit Transfer: 0 1111 1111 1 0 1000 0001 1 0 0000 1011 1 ...

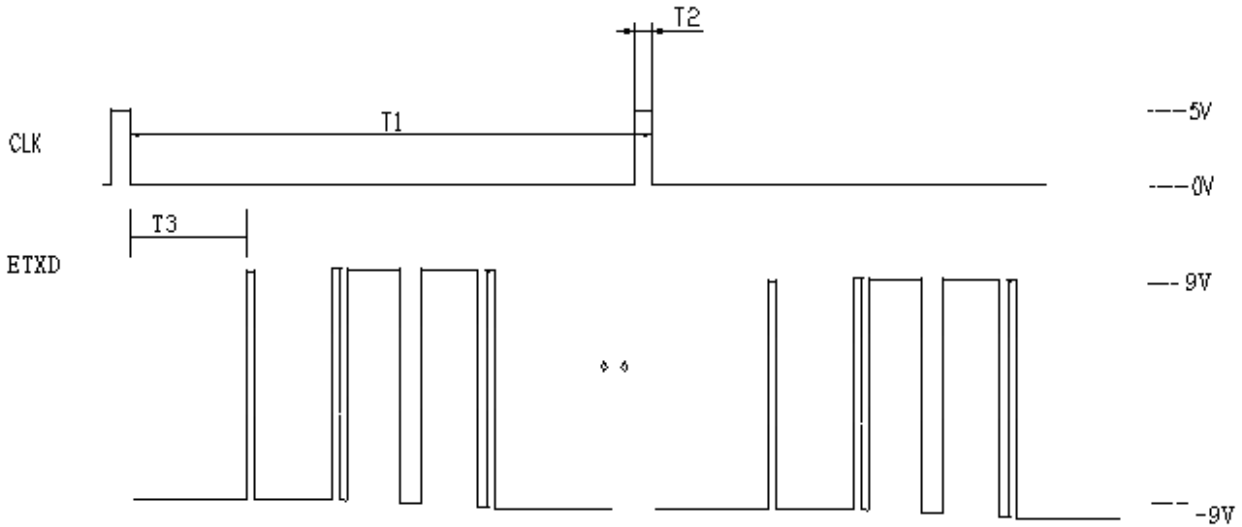

Pulse Handshake: external falling edge pulse signal triggers encoder working

T2 >= 10us

T3: Signal acquisition and processing time after receiving the falling edge outer pulse.

T1-T3: Data Transmission Time

T1, T3 vary according to the actual requirements or customer's needs.

#### (2) Data Frame Format

	1 <sup>st</sup> Byte	2 <sup>nd</sup> Byte	3 <sup>rd</sup> Byte	4 <sup>th</sup> Byte	5 <sup>th</sup> Byte	6 <sup>th</sup> Byte	7 <sup>th</sup> Byte
≤16bit	FFH	81H	The Top Eight Bits	The Bottom Eight Bits	Checksum		
17~24bit	FFH	81H	The Top Eight Bits	The Middle Eight Bits	The Bottom Eight Bits	Checksum	
>24bit	FFH	81H	The Top Eight Bits	The Sub-top Bits	The Middle Eight Bits	The Bottom Eight Bits	Checksum

(Checksum is the sum of first n bytes data and rounded up to the bottom eight bits. n=4(≤16bit); n=5(17~24bit); n=6(>24bit))

#### (3) Connections

Color	Red	Black	Yellow	Green	White	Shield
Signal	VCC	0V	ETXD	NC	CLK	G

#### (4) Angle Conversion Formula

$$\theta = (360^\circ \times a) / 2^n \quad [a: \text{data (decimal)}, n: \text{encoder bits}]$$

Take an example of 14 bit absolute encoder, returned data FFH 81H 01H 7FH 00H, data bit 01H 7FH (decimal) 383, Checksum 00H.

$$a=383, n=14, \theta = (360^\circ \times 383) / 2^{14}, \theta = (360^\circ \times 383) / 16384, \theta = 8.4155^\circ$$

#### (5) Zero Clearing Signal:



Normally the voltage of CLR pin is 3.3V; When customer input a falling edge pulse and VL < 0.5V, zero cleared.

### 3.2.4 Handshake + Zero Clearing

#### (1) Output Data Waveform

For instance: 0xff 0x81 0xd0 ...

TXD + Bit Transfer: 0 1111 1111 1 0 1000 0001 1 0 0000 1011 1 ...

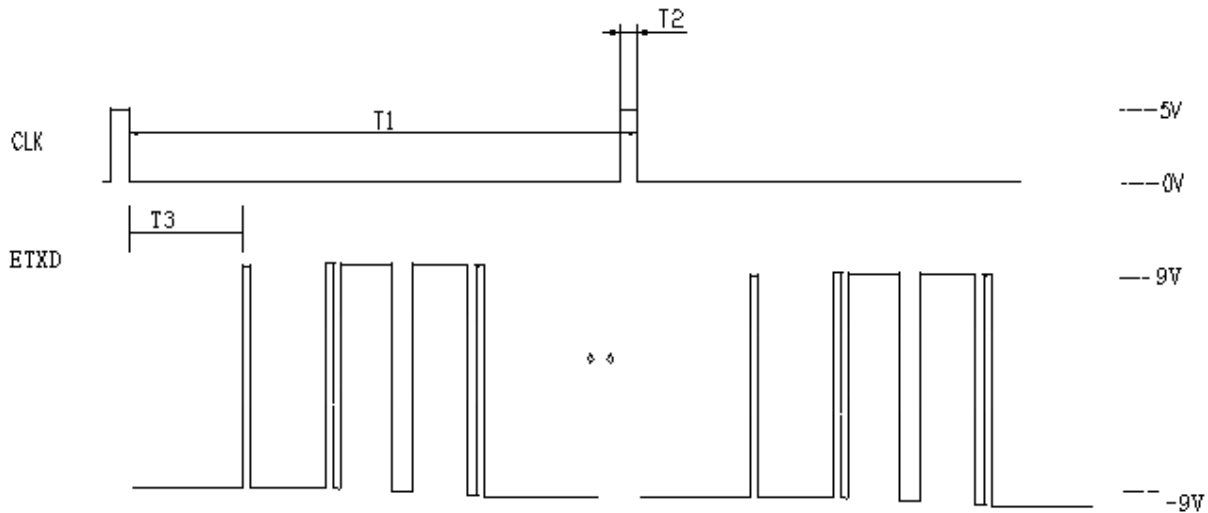

Pulse Handshake: external falling edge pulse signal triggers encoder working

$T2 \geq 10\mu s$

T3: Signal acquisition and processing time after receiving the falling edge outer pulse.

T1-T3: Data Transmission Time

T1, T3 vary according to the actual requirements or customer's needs.

#### (2) Data Frame Format

	1 <sup>st</sup> Byte	2 <sup>nd</sup> Byte	3 <sup>rd</sup> Byte	4 <sup>th</sup> Byte	5 <sup>th</sup> Byte	6 <sup>th</sup> Byte	7 <sup>th</sup> Byte
≤16bit	FFH	81H	The Top Eight Bits	The Bottom Eight Bits	Checksum		
17~24bit	FFH	81H	The Top Eight Bits	The Middle Eight Bits	The Bottom Eight Bits	Checksum	
>24bit	FFH	81H	The Top Eight Bits	The Sub-top Bits	The Middle Eight Bits	The Bottom Eight Bits	Checksum

(Checksum is the sum of first n bytes data and rounded up to the bottom eight bits.  $n=4(\leq 16\text{bit})$ ;  $n=5(17\sim 24\text{bit})$ ;  $n=6(> 24\text{bit})$ )

#### (3) Connections

Color	Red	Black	Yellow	Green	Grey	White	Orange	Brown	Shield
Signal	VCC	0V	ETXD	NC	CLK	CLR	NC	NC	G

#### (4) Angle Conversion Formula

$$\theta = (360^\circ \times a) / 2^n \quad [a: \text{data (decimal)}, n: \text{encoder bits}]$$

Take an example of 14 bit absolute encoder, returned data FFH 81H 01H 7FH 00H, data bit 01H 7FH (decimal) 383, Checksum 00H.

$$a=383, n=14, \theta = (360^\circ \times 383) / 2^{14}, \theta = (360^\circ \times 383) / 16384, \theta = 8.4155^\circ$$

#### (5) Zero Clearing Signal:

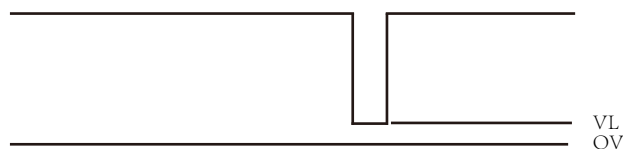

Normally the voltage of CLR pin is 3.3V; When customer input a falling edge pulse and  $VL < 0.5V$ , zero cleared.

### 3.2.5 Bus Command

#### (1) Control Command:

BC AA BX (BX: Command Number. If customers don't have special requirements, each encoder within same batch has sole command number. This number will be also used as encoder address number.)  
For example, 3 encoders in same batch. control command: BC AA B1、BC AA B2、BC AA B3; Corresponding returned data: FF B1....., FF B2 ....., FF B3 .....; The second byte of returned data is product address number.

#### (2) Data Frame Format

	1 <sup>st</sup> Byte	2 <sup>nd</sup> Byte	3 <sup>rd</sup> Byte	4 <sup>th</sup> Byte	5 <sup>th</sup> Byte	6 <sup>th</sup> Byte	7 <sup>th</sup> Byte
Control command	BCH	AAH	BXH				
≤16bit	FFH	81H	The Top Eight Bits	The Bottom Eight Bits	Checksum		
17~24bit	FFH	81H	The Top Eight Bits	The Middle Eight Bits	The Bottom Eight Bits	Checksum	
>24bit	FFH	81H	The Top Eight Bits	The Sub-top Bits	The Middle Eight Bits	The Bottom Eight Bits	Checksum

(Checksum is the sum of first n bytes data and rounded up to the bottom eight bits. n=4(≤16bit); n=5(17~24bit); n=6(>24bit)

#### (3) Connections

Color	Red	Black	Yellow	Green	White	Shield
Signal	VCC	0V	ETXD	NC	CLK	G

#### (4) Angle Conversion Formula

$$\theta = (360^\circ \times a) / 2^n \quad [a: \text{data (decimal)}, n: \text{encoder bits}]$$

Take an example of 14 bit absolute encoder, returned data FFH 81H 01H 7FH 00H, data bit 01H 7FH (decimal) 383, Checksum 00H.  
a=383, n=14,  $\theta = (360^\circ \times 383) / 2^{14}$ ,  $\theta = (360^\circ \times 383) / 16384$ ,  $\theta = 8.4155^\circ$ .

### 3.2.6 Bus +Zero Clearing

#### (1) Control Command:

BC AA BX (BX: Command Number. If customers don't have special requirements, each encoder within same batch has sole command number. This number will be also used as encoder address number.)  
For example, 3 encoders in same batch. control command: BC AA B1、BC AA B2、BC AA B3; Corresponding returned data: FF B1....., FF B2 ....., FF B3 .....; The second byte of returned data is product address number.

#### Zero Clearing Command:

BC AA CX. (CX: zero clearing command. If customers don't have special requirements, each product in same batch has sole zero clearing command. Generally, the X in zero clearing command is corresponding with the X in control command.)

For example, when control command is BC AA B1, its zero clearing command is BC AA C1.

#### (2) Data Frame Format

	1 <sup>st</sup> Byte	2 <sup>nd</sup> Byte	3 <sup>rd</sup> Byte	4 <sup>th</sup> Byte	5 <sup>th</sup> Byte	6 <sup>th</sup> Byte	7 <sup>th</sup> Byte
Control Command	BCH	AAH	BXH				
Zero Clearing Command	BCH	AAH	CXH				
≤16bit	FFH	81H	The Top Eight Bits	The Bottom Eight Bits	Checksum		
17~24bit	FFH	81H	The Top Eight Bits	The Middle Eight Bits	The Bottom Eight Bits	Checksum	
>24bit	FFH	81H	The Top Eight Bits	The Sub-top Bits	The Middle Eight Bits	The Bottom Eight Bits	Checksum

(Checksum is the sum of first n bytes data and rounded up to the bottom eight bits. n=4(≤16bit); n=5(17~24bit); n=6(>24bit)

#### (3) Connections

Color	Red	Black	Yellow	Green	White	Shield
Signal	VCC	0V	ETXD	RTXD	NC	G

#### (4) Angle Conversion Formula

$$\theta = (360^\circ \times a) / 2^n \quad [a: \text{data (decimal)}, n: \text{encoder bits}]$$

Take an example of 14 bit absolute encoder, returned data FFH 81H 01H 7FH 00H, data bit 01H 7FH (decimal) 383, Checksum 00H.  
a=383, n=14,  $\theta = (360^\circ \times 383) / 2^{14}$ ,  $\theta = (360^\circ \times 383) / 16384$ ,  $\theta = 8.4155^\circ$ .

### 3.3.1 Timing Transmission

#### (1) Output Data Waveform

For Example, 0xff 0x81 0xd0 ...

■ TXD+ Bit Transmission: 0 1111 1111 1 0 1000 0001 1 0 0000 1011 1 ...

$3.3V \leq L \leq 5V$

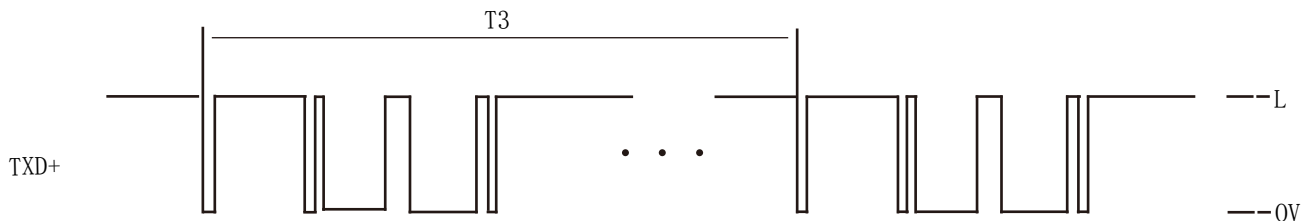

■ TXD- Bit Transmission: 1 0000 0000 0 1 0111 1110 0 1 1111 0100 0 ...

$3.3V \leq L \leq 5V$

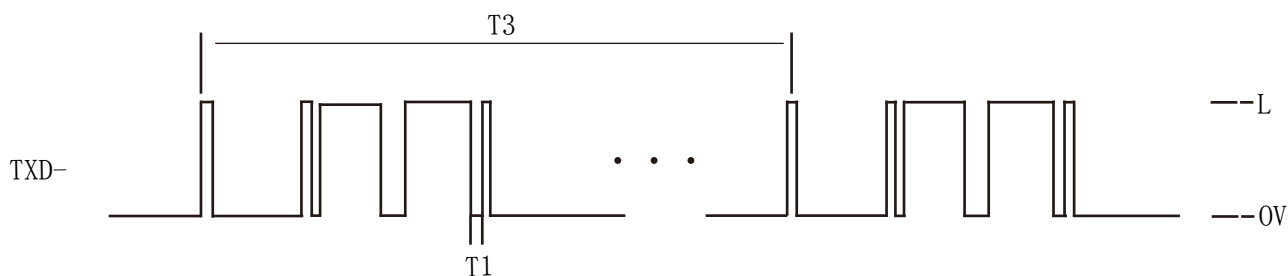

T1: Baud Rate    T3: Refresh Rate

#### (2) Data Frame Format

	1 <sup>st</sup> Byte	2 <sup>nd</sup> Byte	3 <sup>rd</sup> Byte	4 <sup>th</sup> Byte	5 <sup>th</sup> Byte	6 <sup>th</sup> Byte	7 <sup>th</sup> Byte
≤16bit	FFH	81H	The Top Eight Bits	The Bottom Eight Bits	Checksum		
17~24bit	FFH	81H	The Top Eight Bits	The Middle Eight Bits	The Bottom Eight Bits	Checksum	
>24bit	FFH	81H	The Top Eight Bits	The Sub-top Bits	The Middle Eight Bits	The Bottom Eight Bits	Checksum

(Checksum is the sum of first n bytes data and rounded up to the bottom eight bits. n=4(≤16bit); n=5(17~24bit); n=6(>24bit))

#### (3) Connection

Color	RED	BLACK	YELLOW	GREEN	WHITE	SHIELD
Signal	VCC	0V	TXD+	TXD-	NC	G

#### (4) Angle Conversion Formula

$$\theta = (360^\circ \times a) / 2^n \quad [a: \text{data (decimal)}, n: \text{encoder bits}]$$

Take an example of 14 bit absolute encoder, returned data FFH 81H 01H 7FH 00H, data bit 01H 7FH (decimal) 383, Checksum 00H.

$$a=383, n=14, \theta = (360^\circ \times 383) / 2^{14}, \theta = (360^\circ \times 383) / 16384, \theta = 8.4155^\circ.$$



### 3.3.2 Timing Transmission+Zero Clearing

#### (1) Output Data Waveform

For Example 0xff 0x81 0xd0 ...

- TXD+ Bit Transmission: 0 1111 1111 1 0 1000 0001 1 0 0000 1011 1 ...

$3.3V \leq L \leq 5V$

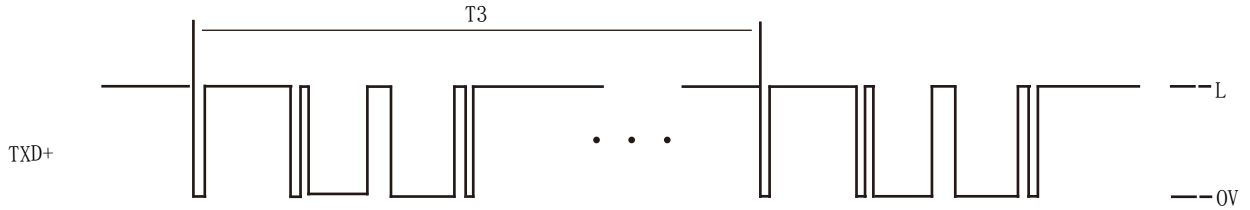

- TXD- Bit Transmission: 1 0000 0000 0 1 0111 1110 0 1 1111 0100 0 ...

$3.3V \leq L \leq 5V$

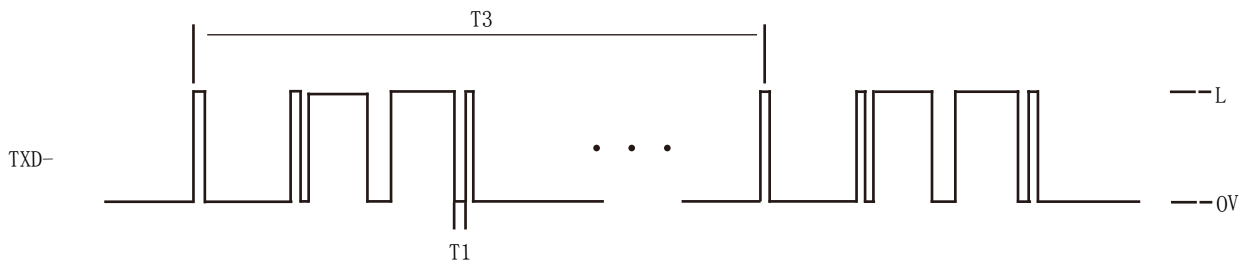

T1: Baud Rate    T3: Refresh Rate

#### (2) Data Frame Format

	1 <sup>st</sup> Byte	2 <sup>nd</sup> Byte	3 <sup>rd</sup> Byte	4 <sup>th</sup> Byte	5 <sup>th</sup> Byte	6 <sup>th</sup> Byte	7 <sup>th</sup> Byte
≤16bit	FFH	81H	The Top Eight Bits	The Bottom Eight Bits	Checksum		
17~24bit	FFH	81H	The Top Eight Bits	The Middle Eight Bits	The Bottom Eight Bits	Checksum	
>24bit	FFH	81H	The Top Eight Bits	The Sub-top Bits	The Middle Eight Bits	The Bottom Eight Bits	Checksum

(Checksum is the sum of first n bytes data and rounded up to the bottom eight bits. n=4(≤16bit); n=5(17~24bit);n=6(>24bit))

#### (3) Connection

Color	Red	Black	Yellow	Green	White	Shield
Signal	VCC	0V	TXD+	TXD-	CLR	G

#### (4) Angle Conversion Formula

$$\theta = (360^\circ \times a) / 2^n \quad [a: \text{data (decimal)}, n: \text{encoder bits}]$$

Take an example of 14 bit absolute encoder, returned data FFH 81H 01H 7FH 00H, data bit 01H 7FH (decimal) 383, Checksum 00H.

$$a=383, n=14, \theta = (360^\circ \times 383) / 2^{14}, \theta = (360^\circ \times 383) / 16384, \theta = 8.4155^\circ.$$

#### (5) Zero Clearing Signal:

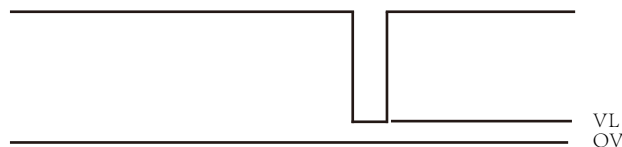

Normally the voltage of CLR pin is 3.3V; When customer input a falling edge pulse and  $V_L < 0.5V$ , zero cleared.

### 3.3.3 Bus Command

#### (1) Output Data Wave Form

For example 0xff 0x81 0xd0 ...

TXD+ Bit Transmission: 0 1111 1111 1 0 1000 0001 1 0 0000 1011 1 ...

$3.3V \leq L \leq 5V$

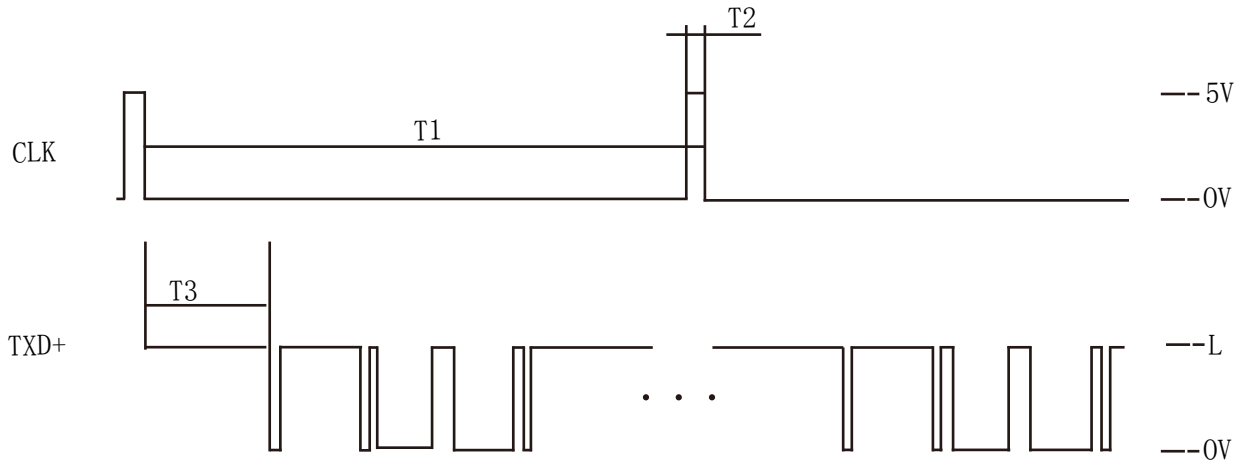

The falling edge of outer pulses signal triggers encoder working

$T2 \geq 10\mu s$

T3: Signal acquisition and processing time after receiving the falling edge outer pulse.

T1-T3: Data transmission time

T1, T3 will be different according to customer's requirements.

#### (2) Data Frame Format

	1 <sup>st</sup> Byte	2 <sup>nd</sup> Byte	3 <sup>rd</sup> Byte	4 <sup>th</sup> Byte	5 <sup>th</sup> Byte	6 <sup>th</sup> Byte	7 <sup>th</sup> Byte
≤16bit	FFH	81H	The Top Eight Bits	The Bottom Eight Bits	Checksum		
17~24bit	FFH	81H	The Top Eight Bits	The Middle Eight Bits	The Bottom Eight Bits	Checksum	
>24bit	FFH	81H	The Top Eight Bits	The Sub-top Bits	The Middle Eight Bits	The Bottom Eight Bits	Checksum

(Checksum is the sum of first n bytes data and rounded up to the bottom eight bits. n=4(≤16bit); n=5(17~24bit); n=6(>24bit))

#### (3) Connections

Color	Red	Black	Yellow	Green	Grey	White	Orange	Brown	Shield
Signal	VCC	0V	TXD+	TXD-	CLK+	CLK-	NC	NC	G

#### (4) Angle Conversion Formula

$$\theta = (360^\circ \times a) / 2^n \quad [a: \text{data (decimal)}, n: \text{encoder bits}]$$

Take an example of 14 bit absolute encoder, returned data FFH 81H 01H 7FH 00H, data bit 01H 7FH (decimal) 383, Checksum 00H.

$$a=383, n=14, \theta = (360^\circ \times 383) / 2^{14}, \theta = (360^\circ \times 383) / 16384, \theta = 8.4155^\circ$$

### 3.3.4 Bus + Zero Clearing

#### (1) Output Data Wave Form

For example 0xff 0x81 0xd0 ...

TXD+ Bit Transmission: 0 1111 1111 1 0 1000 0001 1 0 0000 1011 1 ...

$3.3V \leq L \leq 5V$

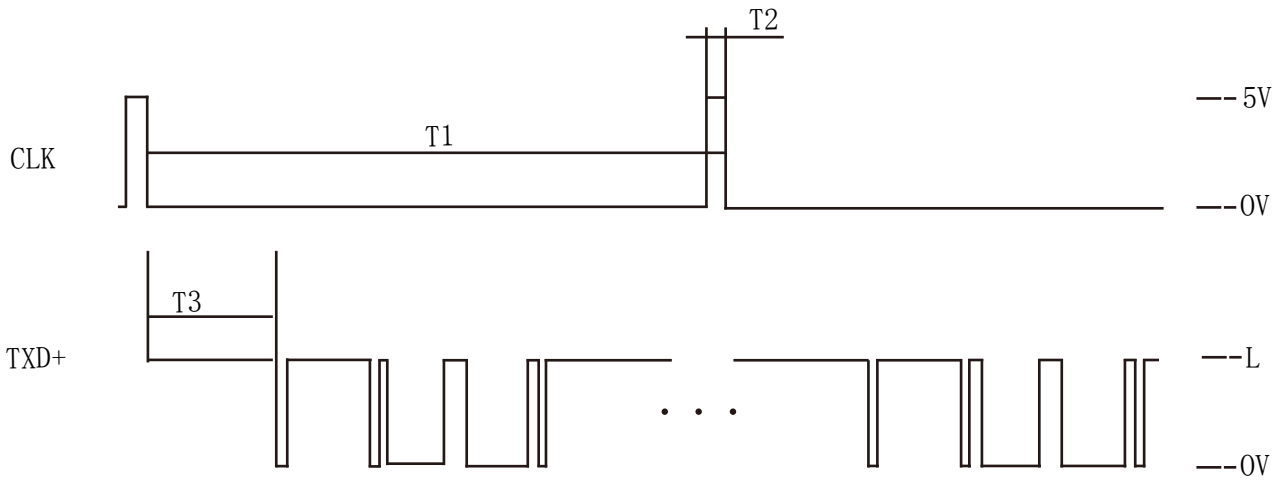

The falling edge of outer pulses signal triggers encoder working

$T2 \geq 10\mu s$

T3: Signal acquisition and processing time after receiving the falling edge outer pulse.

T1-T3: Data transmission time

T1, T3 will be different according to customer's requirements.

#### (2) Data Frame Format

	1 <sup>st</sup> Byte	2 <sup>nd</sup> Byte	3 <sup>rd</sup> Byte	4 <sup>th</sup> Byte	5 <sup>th</sup> Byte	6 <sup>th</sup> Byte	7 <sup>th</sup> Byte
$\leq 16\text{bit}$	FFH	81H	The Top Eight Bits	The Bottom Eight Bits	Checksum		
17~24bit	FFH	81H	The Top Eight Bits	The Middle Eight Bits	The Bottom Eight Bits	Checksum	
$> 24\text{bit}$	FFH	81H	The Top Eight Bits	The Sub-top Bits	The Middle Eight Bits	The Bottom Eight Bits	Checksum

(Checksum is the sum of first n bytes data and rounded up to the bottom eight bits.  $n=4(\leq 16\text{bit})$ ;  $n=5(17\sim 24\text{bit})$ ;  $n=6(> 24\text{bit})$ )

#### (3) Connection

Color	Red	Black	Yellow	Green	White	Shield
Signal	VCC	0V	TXD+	TXD-	CLR	G

#### (4) Angle Conversion Formula

$$\theta = (360^\circ \times a) / 2^n \quad [a: \text{data (decimal)}, n: \text{encoder bits}]$$

Take an example of 14 bit absolute encoder, returned data FFH 81H 01H 7FH 00H, data bit 01H 7FH (decimal) 383, Checksum 00H.

$$a=383, n=14, \theta = (360^\circ \times 383) / 2^{14}, \theta = (360^\circ \times 383) / 16384, \theta = 8.4155^\circ$$

3.4.1 CANopen ——— CAN interface chip-----SN65HVD230 CANopen protocol

(1) The Data Received As Shown Below:

序列	通道号	时间标识 (ms)	传输方向	帧ID (Hex)	帧类型	帧格式	数据长度	数据 (Hex)
002365	0	000936990.5	接收	000001FF	标准帧	数据帧	08	02 2B 00 00 00 00 00 00
002366	0	000937096.9	接收	000001FF	标准帧	数据帧	08	02 2B 00 00 00 00 00 00
002367	0	000937203.3	接收	000001FF	标准帧	数据帧	08	02 2B 00 00 00 00 00 00
002368	0	000937309.7	接收	000001FF	标准帧	数据帧	08	02 2B 00 00 00 00 00 00
002369	0	000937416.1	接收	000001FF	标准帧	数据帧	08	02 2B 00 00 00 00 00 00
002370	0	000937522.5	接收	000001FF	标准帧	数据帧	08	02 2B 00 00 00 00 00 00

Correspondence Signal Wave:

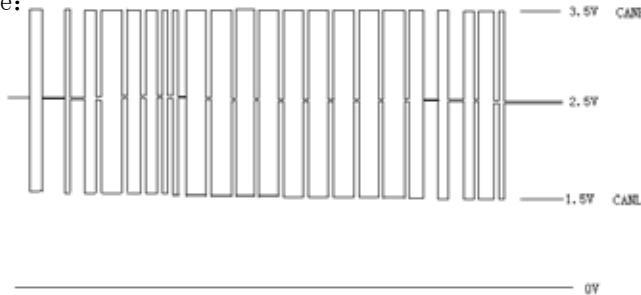

(2) Parameter Settings

The encoder with factory baud rate 250K, the node number 20H, the programming cycle time 100ms. CANopen Data Format Description:

COB-ID	Command	Index		Subindex		Data		
		Byte1	Byte 2	Byte 3	Byte 4	Byte 5	Byte 6	Byte 7
11bit	Byte 0	low	High	Low	——	——	——	High

COB-ID Composition Description:

10	9	8	7	6	5	4	3	2	1	0
Function Code				Device Address						
X	X	X	X	X	X	X	X	X	X	X

Function code can be used:

Function	Code (bit)	COB-ID
NMT	0000	0
SYNC	0001	128 (70H)
Emergency	0001	129-255 (71H-FFH)
PDO (RX)	0011	385-511 (181H-1FFH)
PDO (TX)	0100	513-639 (201H-27F)
SDO (RX)	1011	1409-1535 (581H-5FFH)
SDO (TX)	1100	1537-1663 (601H-67FH)

RX/TX was output by the PC , , RX encoder data issue, TX encoder data reception.

Under CAN open protocol product properly grounded electrical wiring, select the correct baud rate, the boot device, open electricity, the software will automatically receive a data, you can see the current frame ID, such as the following figure frame ID 000001FF. At this point the encoder node number is FF, send 2FF, 01, FF, 0, 0, 0, 0, 0 start No.FF encoder.

Note: Frame enter configuration mode ID input is 7E5

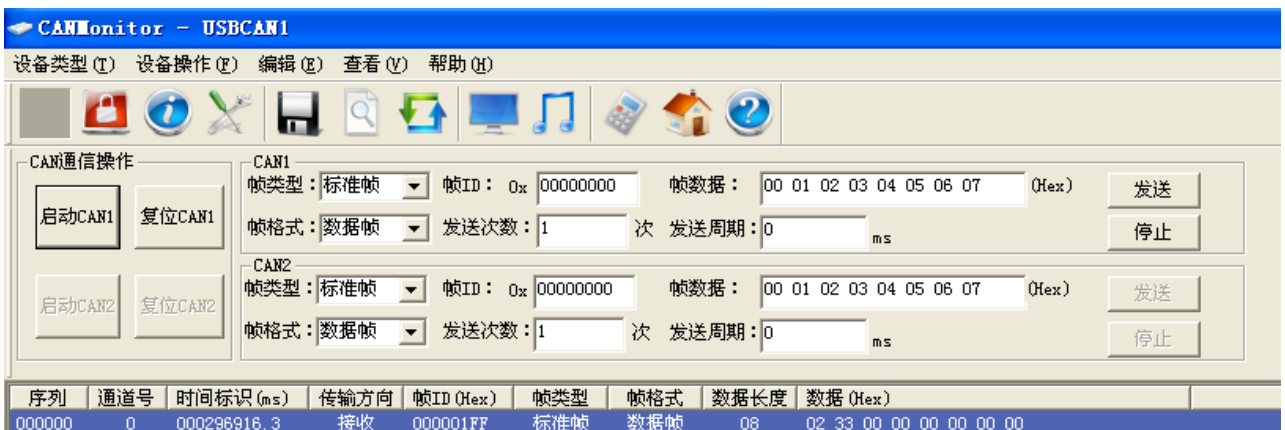

(3) Absolute encoders CANopen protocol setup instructions:

The following relates to the CAN bus data format are frame ID, D0, D1, D2, D3, D4, D5, D6, D7 all data is hexadecimal, assuming the encoder node number is NN, DLC are 8.

①

	FrameID	D0	D1	D2	D3	D4	D5	D6	D7	
Send:	2NN	01	NN	0	0	0	0	0	0	Start NN node
Or send:	2NN	80	NN	0	0	0	0	0	0	Jog No. NN encoder
Reply:	1NN	The Bottom Eight Bits	The Top Eight Bits	0	0	0	0	0	0	Resend data

②

	FrameID	D0	D1	D2	D3	D4	D5	D6	D7	
Send:	7E5	04	01	0	0	0	0	0	0	Enter configuration mode
Or send:	7E5	11	20	0	0	0	0	0	0	Set a new node address as 0x20
Reply:	7E5	11	00	0	0	0	0	0	0	Success

③

	FrameID	D0	D1	D2	D3	D4	D5	D6	D7	(00:1M, 02:500K, 03:250K)
Send:	7E5	04	01	0	0	0	0	0	0	Enter configuration mode
Or send:	7E5	13	00	02	0	0	0	0	0	Set new baud rate to 500K
Reply:	7E5	13	00	0	0	0	0	0	0	Success

④

	Frame ID	D0	D1	D2	D3	D4	D5	D6	D7	
Send:	2NN	22	NN	0	0	0	0	0	0	NN Node positive carry
Reply:	1NN	22	00	0	0	0	0	0	0	

⑤

	FramID	D0	D1	D2	D3	D4	D5	D6	D7	
Send:	2NN	22	NN	0	0	0	0	0	0	NN inverse carry Node
Reply:	1NN	22	00	0	0	0	0	0	0	

⑥

	framID	D0	D1	D2	D3	D4	D5	D6	D7	
Send:	2NN	20	NN	0	0	0	0	0	0	Setting NN Node
Reply:	1NN	20	00	0	0	0	0	0	0	

⑦

	FramID	D0	D1	D2	D3	D4	D5	D6	D7	
Send:	2NN	31	NN	TT	0	0	0	0	0	NN node to transmit data timing TT times / S
Rpely:	1NN	31	00	0	0	0	0	0	0	

⑧

	FramID	D0	D1	D2	D3	D4	D5	D6	D7	
Send:	2NN	31	NN	TT	0	0	0	0	0	Stop NN Node timed transmission mode
Reply:	1NN	31	00	0	0	0	0	0	0	

(4) Connection

Color	Red	Black	Yellow	Green	White	Shield
Signal	VCC	0V	NC	CANL	CANH	G

(5) Angle Conversion Formula

$$\theta = (360^\circ \times a) / 2^n \quad (a: \text{data (Decimal)}, n: \text{Encoder Resolution in Bits})$$

For example: 14 bit absolute encoder, return frame ID 0120H data frame 47H 26H 00H 00H 00H 00H 00H, data bits 47H 26H (decimal 9799).

$$a=9799, n=14, \theta = (360^\circ \times 9799) / 2^{14}, \theta = (360^\circ \times 9799) / 16384,$$

$$\theta = 215.3100^\circ$$

**Synchronous Serial:** communication rate in the contract, the sender and the receiver clock signal frequency and phase are always consistent (synchronous).

3.5 SSI

SSI Interface Chip---MAX3087 ESA

Two-wire system: single-ended clock input, single-ended data output.

Absolute position value triggered by the clock signal, the output of the clock signal synchronized with the serial signal from the upper (MSB), when not transmitting a signal, a clock and data are high, in the first falling edge of the clock signal, the current start value stored on the rising edge of the clock signal starts transmitting data. Signal high between 3.3V-5V.

If the clock appears excessive abnormal angle, for example: 12 bits SSI encoder sends 14 bits clock reads the data, the maximum angle values of thousands of degrees, and no full-1 status, if the timing happens to fit, the extra clock will read out repeat the high-order data. If the clock is less than the normal requirements, send eight clock read 12 encoder data, and with eight of the angle conversion mode, the data may not be wrong; with 12 angle conversion method, the maximum angle of 22.4121 degrees.

(1) Data Output Waveform

For example 1: 12 bits SSI Clock

DATA+ Transmission: 0 0 0 0 0 0 0 0 0 0 0 0

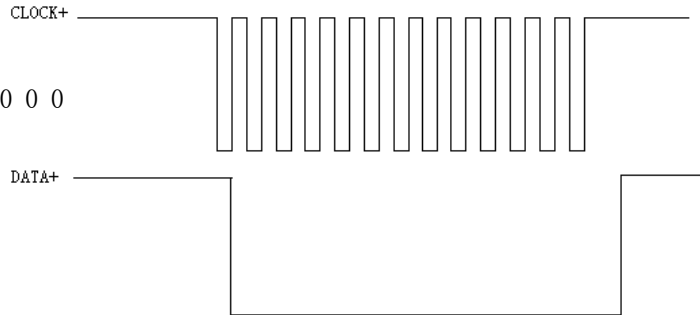

For example 2: 12 bits SSI Clock

DATA+ Bit Transmission: 0 0 0 1 1 1 1 0 1 1 1 1

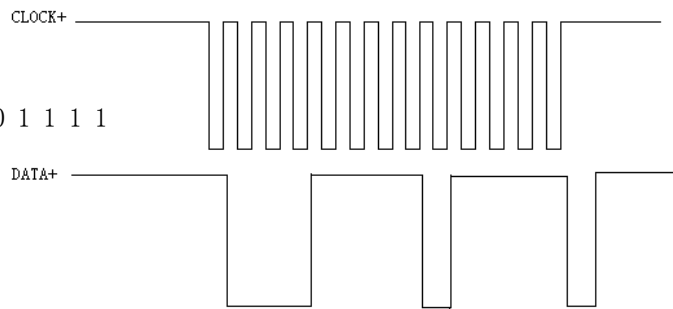

(2) Interface Timing

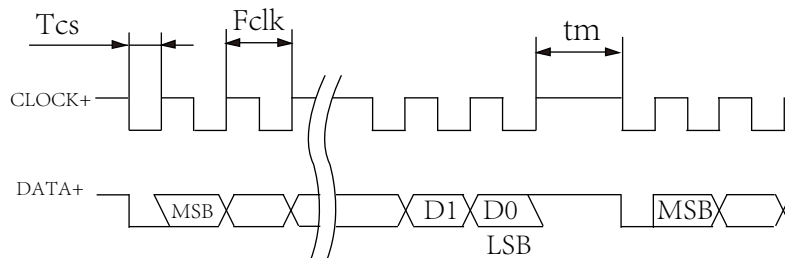

Absolute position values are triggered clock signal, the output of the clock signal synchronized with the serial signal from the upper (MSB), when not transmitting a signal, a clock and data are high, in the first falling edge of the clock signal, the present value storage, transfer clock rising edge of the start signal for starting data.

Note:  $T_{cs} > 4\mu s$ ;  $100kHz < f_{clk} < 250kHz$ ;  $T_m > 500\mu s$ ;

Note:  $T_{cs}$   $f_{clk}$   $T_m$  Products vary according to the actual situation.

(3) Connection

8 Pin Cable

Color	Red	Black	Yellow	Green	Gray	White	Yellow	Brown	Shield
Signal	VCC	0V	NC	D+	C+	C-	NC	D-	G

6 Pin Cable

Color	Red	Black	Green	Brown	Gray	White	Shield
Signal	VCC	0V	D+	D-	C+	C-	G

(4) Angle Conversion Formula

$\theta = (360^\circ \times a) / 2^n$  . (a: Data (Decimal) , n: Resolution in bits of Encoder)

For example: 12 bits absolute encoder SSI protocol returns data DATA + Bit Transfer: 000111101111 (decimal 495)

$a=495$ ,  $n=12$ ,  $\theta = (360^\circ \times 495) / 2^{12}$  ,  $\theta = (360^\circ \times 495) / 4096$ ,  $\theta = 43.5058^\circ$

